

## Development and Evaluation of A Garlic Peeling Machine

Hussien A. Kassem \*, Adel H. Bahnasawy \*\*, Taha H. Ashour\*\*, El-Sayed G. Khater\*\*\*, Ragab K. Mahmoud \*\*\*\*

\* Graduate Student of Agric. Eng. Dep., Fac. of Agric., Benha Univ., Egypt

\*\* Professor of Agric. Eng., Fac. of Agric., Benha Univ., Egypt

\*\*\* Associate Professor of Agric. Eng., Fac. of Agric., Benha Univ., Egypt

\*\*\*\*Lecturer of Agric. Eng., Fac. of Agric. Eng., El-Azhr Univ. (Assuit Branch), Egypt

Corresponding author: [alsayed.khater@fagr.bu.edu.eg](mailto:alsayed.khater@fagr.bu.edu.eg)

### Abstract

The main aim of the present study is develop, manufacture and evaluate a garlic peeler which is made from local raw materials. The effect of different rotational speeds of disk (210, 240 and 270 rpm), operating times (1, 2 and 3 min) and batch loads (0.5, 1.0 and 1.5 kg) were studied. The peeler productivity, efficiency, damage cloves percentage, specific energy consumption and costs were determined. The obtained results indicated that the garlic peeler productivity increased from 17.88 to 19.33 and 8.52 to 29.04 kg h<sup>-1</sup>, with increasing rotational speed of disk and operating time, respectively and it decreased from 28.84 to 12.46 kg h<sup>-1</sup> with increasing batch load from 0.5 to 1.5 kg. The peeler efficiency increased with increasing rotational speed of disk, operating time and batch load. The highest value of damaged cloves percentage (0.26%) was found for 270 rpm rotational speed of disk at 1 min of operating time for 1.5 batch load. The specific energy consumption decreases with increasing rotational speed of disk and operating time. The total cost of garlic peeler decreased from 0.230 to 0.215 and 0.402 to 0.105 EGP kg<sup>-1</sup> with increasing rotational speed of disk and operating time, respectively.

**Keywords:** Garlic, peeler, Productivity, Efficiency, Energy, Cost

### Introduction

Garlic (*Allium sativum* L.) is one of the most important vegetables throughout the world with a total harvested area in Egypt of 15503 ha and an annual production of 318800 tons of dry bulbs (FAO, 2019). The importance of garlic is due to its use not only for culinary but also for therapeutic and medicinal purposes in both traditional and modern medicine. It is consumed either as raw vegetable (fresh leaves or dried cloves), or after processing in the form of garlic oil, garlic extracts and garlic powder with differences in chemical composition and bioactive compounds content between the various forms (Lanzotti *et al.*, 2014).

Garlic processing involves bulb breaking, peeling, dehydration, grinding and other unit operations. Garlic peeling is one of the most important and essential key unit operations prior to any subsequent processing activity. During garlic peeling, the thin membranous skin, inedible part is to be removed off from the segments. Typical size of the cloves makes the peeling to be very tedious and time consuming operation. Traditional peeling methods, including hand peeling, flame peeling, oven peeling and chemical peeling (Dhananjay *et al.*, 2015).

Recent developments in garlic technology have been limited to production level only and very little attention has been given on the processing and preservation aspects of garlic. Post-harvest losses of

garlic do take place to the extent of 15-50 % depending on the variety and post-harvest unit operation. The losses may increase if proper post-harvest management practices are not followed. Therefore, in order to minimize these huge losses, garlic is needed to be processed. Garlic can be processed into various products like garlic powder, garlic flakes, garlic paste, garlic salt etc., which are in very much demand not only in domestic but also in international markets (Anonymous, 2001). In general, the objective of peeling is to remove the outer layer. The selection of the proper peeling method is of prime importance, as the quality of the finished product depends, to a large extent, upon the method used. The amount of peel removed is important to the processor not only because it is a total loss and reduces product quantity, but also for the cost intensive nature of peel disposal which otherwise causes environmental pollution. It is worth mentioning that the peeling requirement for different products varies. Hence, aim of good peeling operation are minimizing product loss. Minimizing energy and chemical usage, minimizing time of operation and peeling cost. Peeling not only improves the product quality by removing the non-edible outer thin membranous skin but also hasten the drying process so that energy and drying time can be reduced (Mudgal *et al.*, 1998).

From the previous review, it is concluded that the traditional methods of garlic peeling are very expensive, time consuming and have low efficiency,

besides, the exported machines of garlic peeling are very expensive and needs high levels of skills and maintenance, therefore, the main aim of this work which is to develop, manufacture and evaluate a garlic peeler which is made from local raw materials, low cost in operating, low garlic damage, easy and simple to handle.

### Materials and Methods

The experiment was carried out at Agricultural and Bio-Systems Engineering Department Faculty of

Agriculture Moshtohor, Benha University, Egypt, during 2020 season.

### 2.1. Materials

The garlic bulbs (Egyptian Baladi variety) were brought from the local farms, at the beginning of the season, which has a Moisture content  $67.0 \pm 0.3$  % w.b.

#### 1.1.1. Peeler description

The designed peeler was manufactured in a private workshop. Figures 1 and 2 show the isometric drawing and the orthographic drawing of the machine. The components of the machine include the machine frame, rotating peeling disk, inlet and outlet and power source.

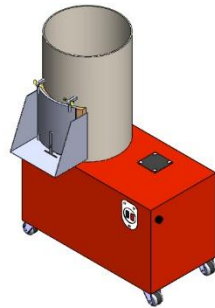
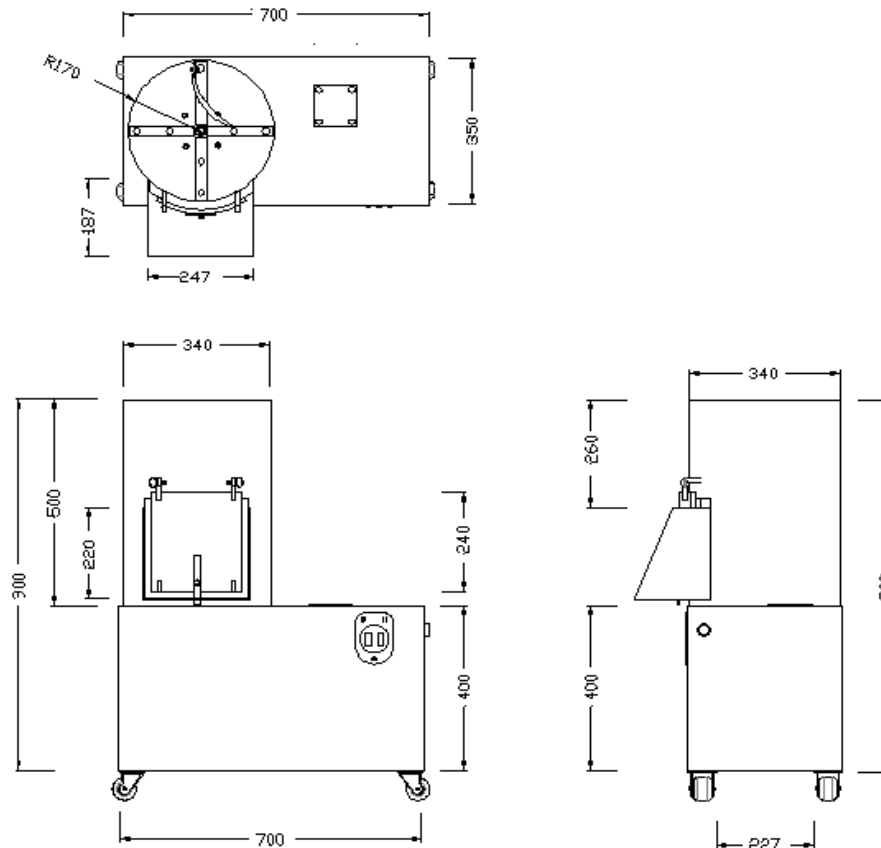

Figure (1): Isometric drawing of the peeler.



dim. in mm

Figure (2): Orthographic drawing of the peeler.

### 2.1.1. The machine frame

The main frame of the machine was constructed from steel (2 mm thickness). Dimensions of the machine frame are 700 mm long, 400 mm for wide and 900 mm for height. All important parts of peeling machine were constructed from anti-rust materials.

### 2.1.2. Peeling chamber

The peeling chamber is vertical cylinder of steel, its dimensions of 340 mm inner diameter, 500 mm high and 2 mm thickness.

### 2.1.3. Peeling disk

The rotating peeling disk is made from steel with diameter of 330 mm and 5 mm thickness was

fixed in the bottom of the peeling chamber by metal axis (10 mm diameter and 75 mm length) passes through the base and connected with power source. The top surface of the disk contains four feathers made of rubber. The dimensions of feather are 150 mm long, 24 mm wide and 10 mm thickness, the feather was installed on the turntable by 2 nails (8 mm diameter and 20 mm long) are shown in figure (3). The garlic cloves move inside the peeling chamber by the rotating disk, resulting in friction between the garlic cloves and fins, leading to the separation of peel.

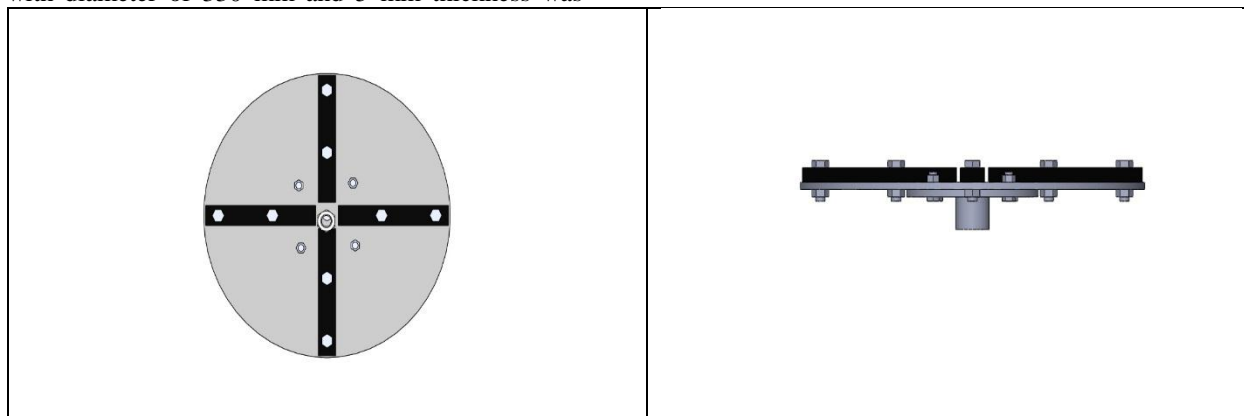

Figure (3): Peeling disk

### 2.1.4. Source of power

The peeling machine is driven by 0.56 kW (0.75 hp), single phase electric motor. The power was transmitted to main shaft of the rotating peeling disk by different changeable sizes of pulleys and V-shaped belts, to regulate the speed of motor from 1400 rpm to the required cutting speeds, which are 210, 240 and 270 rpm.

## 2.2. Methods

The developed peeling machine was evaluated by studying the effect of machine parameters such as speed, time and batch load on the productivity, damage, efficiency, power requirements and cost.

### 2.2.1. Experimental design

The treatments were arranged in a split-split plot design in three replications. Three speeds are 210, 240 and 270 rpm. Three operating times are 1, 2 and 3 min and three Batch loads are 0.5, 1.0 and 1.5 kg.

### 2.2.2. Measurements

#### 2.2.2.1. Machine productivity

The machine productivity ( $\text{kg h}^{-1}$ ) was defined as the load of the garlic cloves divided by the total peeling time. The machine productivity was estimated from equation:

$$Pr = \frac{L}{T} \quad (1)$$

Where:

Pr is the machine productivity,  $\text{kg h}^{-1}$

L is the load, kg

T is the peeling time, h

#### 2.2.2.2. Damage percentage:

Damage percentage incurred by machine was estimated from equation:

$$P.L = \frac{\text{Total mass of sample} - \text{Mass after peeling}}{\text{Total mass}} \times 100 \quad (2)$$

Where:

P.L is the percentage of loss, %

#### 2.2.2.3. Machine cutting efficiency

Machine cutting efficiency was estimated from equation:

$$\eta = (100 - P.L) \quad (3)$$

Where:

$\eta$  is the machine cutting efficiency, %

#### 2.2.2.5. Power and energy requirement for slicing machine

The power requirement (kW) was estimated by using the clamp meter to measure the line current strength (I) and the potential difference value (V).

The total electric power requirement under machine working load (P) was calculated according to **Kurt (1979)** by the following equation:

$$P = \frac{I \times V \times \cos \theta}{1000} \quad (4)$$

Where:

P is the power requirement to peeling turnip, kW

I is the line current strength, Amperes.

V is the potential difference, Voltage.

Cos  $\theta$  is the power factor, equal 0.8.

The specific energy consumption (SEC) in kW.h kg<sup>-1</sup> was calculated by using the following equation:

$$SEC = \frac{P}{Pr} \quad (6)$$

Where:

SEC is the specific energy consumption, W.h kg<sup>-1</sup>

### 2.3. Total Costs

The cost calculation based on the following parameters was also performed:

#### Fixed costs (Fc)

- Depreciation costs (D<sub>c</sub>)

$$D_c = \frac{P_d - S_r}{L_d} \quad (7)$$

Where:

D<sub>c</sub> is the depreciation cost, EGP (Egyptian pound) year<sup>-1</sup>. (\$ = 15.63 EGP)

P<sub>d</sub> is the Machine price, 3000 EGP.

S<sub>r</sub> is the salvage rate (0.1P<sub>d</sub>) EGP.

L<sub>d</sub> is the Life expected, year.

- Interest costs (I<sub>n</sub>):

$$I_n = \frac{P_d + S_r}{2} \times i_n \quad (8)$$

Where:

I<sub>n</sub> is the interest, EGP year<sup>-1</sup>.

i<sub>n</sub> is the interest as compounded annually, decimal. (12%)

Shelter, taxes and insurance costs (S<sub>i</sub>):

Shelter, taxes and insurance costs were assumed to be 3 % of the purchase price of the machine (P<sub>m</sub>).

Then:

Fixed cost = D<sub>c</sub> + I<sub>n</sub> + 0.03 P<sub>m</sub> / hour of use per year (9)

#### Variable (operating) costs (Vc):

- Repair and maintenance costs (R<sub>m</sub>):

R<sub>m</sub> = 100 % depreciation cost / hour of use per year (10)

- Energy costs (E):

$$E = EC \times EP \quad (11)$$

Where:

E is the energy costs, EGP h<sup>-1</sup>.

EC is the electrical energy consumption, kWh.

EP is the energy price, 0.57 EGP kW<sup>-1</sup>.

Labor costs (L<sub>a</sub>):

$$L_a = \text{Salary of one worker} \times \text{No. of workers} \quad (12)$$

Where:

L<sub>a</sub> is the Labor costs, EGP h<sup>-1</sup>.

Salary of one worker = 10 EGP h<sup>-1</sup>.

No. of workers = 1

Then:

$$\text{Variable costs} = R_m + E + L_a \quad (13)$$

#### Total costs (T<sub>c</sub>):

$$\text{Total costs} = \text{Fixed costs} + \text{Variable costs} \quad (14)$$

## Results and Discussion

### 3.1. Peeler productivity:

Table (1) and figures (4, 5 and 6) show the productivity of garlic peeler machine as affected by the rotational speeds of peeler disk from 210 to 270 rpm, the operating times from 1 to 3 min and batch loads from 0.5 to 1.5 kg. The results indicate that the peeler productivity increases with increasing rotational speed of disk and operating time and decreased with increasing batch load. It indicates that when the rotational speed of disk increased from 210 to 270 rpm, the machine productivity increased from 17.88 to 19.33 (by 7.50 increment percent) kg h<sup>-1</sup>. It also indicates that when the operating time increased from 1 to 3 min, the machine productivity increased from 8.52 to 29.04 (by 70.66 increment percent) kg h<sup>-1</sup>, while the machine productivity decreased from 28.84 to 12.46 (by 56.80 reduction percent) kg h<sup>-1</sup> when the batch load increased from 0.5 to 1.5 kg.

It could be noticed that increasing the rotational speed of disk from 210 to 270 rpm, tends to increase the peeler productivity from 26.50 to 28.68, 15.20 to 16.56 and 11.95 to 12.75 kg h<sup>-1</sup> at 0.5, 1.0 and 1.5 kg batch load, respectively, when the rotational speeds of disk increased from 210 to 270 rpm. The results also indicate that the peeler productivity decreased from 26.50 to 11.95, 31.34 to 12.67 and 28.68 to 12.75 kg h<sup>-1</sup> at 210, 240 and 270 rpm rotational speeds of disk, respectively, when the batch load increased from 0.5 to 1.5 kg as shown in figure 4. The trend of these results agreed with those obtained by **Badr (2017)**.

**Table 1.** Peeler productivity at different rotational speeds of dish, operating times and batch loads.

Speed, rpm	Time, min	Batch Load, kg			Mean
		0.5	1.0	1.5	
Peeler Productivity, kg <sup>-1</sup>					
210	1	13.14	7.20	4.60	<b>8.31</b>
	2	27.36	14.70	11.20	<b>17.75</b>
	3	39.00	23.70	20.04	<b>27.58</b>
	<b>Mean</b>	<b>26.50</b>	<b>15.20</b>	<b>11.95</b>	
240	1	13.50	7.05	4.12	<b>8.22</b>
	2	36.06	18.87	13.78	<b>22.90</b>
	3	44.46	26.70	20.10	<b>30.42</b>
	<b>Mean</b>	<b>31.34</b>	<b>17.54</b>	<b>12.67</b>	
270	1	14.94	7.20	4.92	<b>9.02</b>
	2	29.70	18.09	11.78	<b>19.86</b>
	3	41.40	24.39	21.56	<b>29.12</b>
	<b>Mean</b>	<b>28.68</b>	<b>16.56</b>	<b>12.75</b>	
<b>Mean of speed</b>		17.88	20.52		19.33
<b>Mean of time</b>		8.52	250.17		29.04
<b>Mean of batch</b>		28.84	16.43		12.46

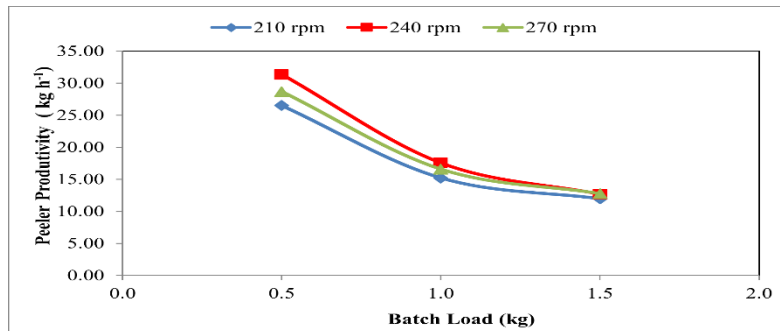
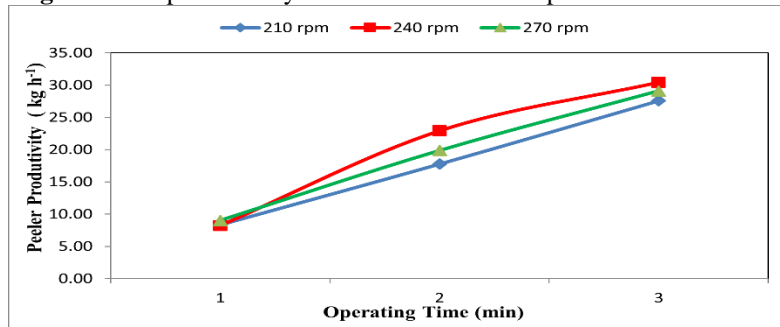
**Fig. 4.** Peeler productivity at different rotational speeds and batch loads.**Fig. 5.** Peeler productivity at different rotational speeds of disk and operating times.

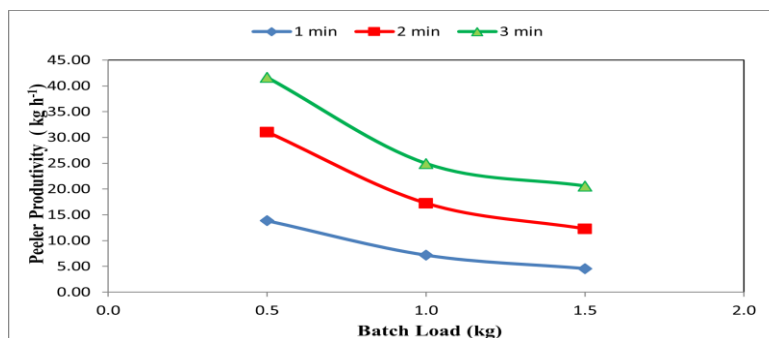

Fig. 6. Peeler productivity at different operating times and batch loads.

Regarding the effect of rotational speed of disk and operating time and on the peeler productivity, the results indicate that the garlic peeler productivity increases with increasing the rotational speed of disk and operating time. It increased from 8.31 to 9.02, 17.75 to 19.86 and 27.58 to 29.12 kg h<sup>-1</sup> at 1, 2 and 3 min operating time, respectively, when the rotational speed of disk increased from 210 to 270 rpm. The results also indicate that the garlic peeler productivity increased from 8.31 to 27.58, 8.22 to 30.42 and 9.02 to 29.12 kg h<sup>-1</sup> at 210, 240 and 270 rpm rotational speed of disk, respectively, when the operating time increased from 1 to 3 min as shown in figure 5.

The results also indicate that the peeler productivity increased from 13.86 to 41.62, 7.15 to 24.93 and 4.55 to 19.23 kg h<sup>-1</sup> at 0.5, 1.0 and 1.5 kg batch loads, respectively, when the operating time increased from 1 to 3 min. The results also indicate that the peeler productivity decreased from 13.86 to 4.55, 31.04 to 12.25 and 41.62 to 19.23 kg h<sup>-1</sup> at 1, 2 and 3 min operating times, respectively, when the batch load increased from 0.5 to 1.5 kg as shown in figure 6.

Multiple regression analysis was carried out to obtain a relationship between the garlic peeler productivity as dependent variable and different rotational speed of disk, operating time and batch load as independent variables. The best fit for this relationship is presented in the following equation:-

$$P = 9.32 + 0.02RS + 10.26OT - 16.38PL \quad R^2 = 0.90 \quad (15)$$

Where:

P is the garlic peeler productivity, kg h<sup>-1</sup>

RS is the rotational speed of disk, rpm

OT is the operating time, min

BL is the batch load, kg

This equation could be applied in the range of 210 to 270 rpm of rotational speed of disk, from 1 to 3 min operating time and from 0.5 to 1.5 kg batch load.

### 3.2. Peeler efficiency:

Table (2) and figures (7, 8 and 9) show the efficiency of garlic peeler as affected by the rotational speeds of peeler disk from 210 to 270 rpm, the operating times from 1 to 3 min and batch loads from 0.5 to 1.5 kg. The results indicate that the peeler efficiency increases with increasing rotational speed of disk and operating time and batch load. It indicates that when the rotational speed of disk increased from 210 to 270 rpm, the peeler efficiency increased from 50.13 to 52.71 (by 4.89 increment percent) %. It also indicates that when the operating time increased from 1 to 3 min, the peeler efficiency increased from 46.77 to 55.25% (by 15.95 increment percent), while the machine productivity increased from 48.06 to 56.95 (by 15.61 increment percent) % when the batch load increased from 0.5 to 1.5 kg.

It could be noticed that increasing the rotational speed of disk 210 to 270 rpm, tends to increase the peeler efficiency from 44.24 to 48.43, 49.89 to 54.17 and 56.27 to 55.54 % at 0.5, 1.0 and 1.5 kg batch load, respectively, when the rotational speeds of disk increased from 210 to 270 rpm. The results also indicate that the peeler efficiency increased from 44.24 to 46.27, 51.50 to 59.03 and 48.43 to 55.54 % at 210, 240 and 270 rpm rotational speeds of disk, respectively, when the batch load increased from 0.5 to 1.5 kg as shown in figure 7.

**Table 2.** Peeler efficiency at different rotational speeds of dish, operating times and batch loads.

Speed, rpm	Time, min	Batch Load, kg			Mean
		0.5	1.0	1.5	
		Peeler Efficiency, %			
210	1	43.80	48.00	46.00	<b>45.93</b>
	2	45.60	49.00	56.00	<b>50.20</b>
	3	43.33	52.67	66.80	<b>54.27</b>
	<b>Mean</b>	<b>44.24</b>	<b>49.89</b>	<b>56.27</b>	
240	1	45.00	47.00	41.20	<b>44.40</b>
	2	60.10	62.90	68.90	<b>63.97</b>
	3	49.40	59.33	67.00	<b>58.58</b>
	<b>Mean</b>	<b>51.50</b>	<b>56.41</b>	<b>59.03</b>	
270	1	49.80	48.00	49.20	<b>49.00</b>
	2	49.50	60.30	58.90	<b>56.23</b>
	3	46.00	54.20	58.53	<b>52.91</b>
	<b>Mean</b>	<b>48.43</b>	<b>54.17</b>	<b>55.54</b>	
<b>Mean of speed</b>		50.13	55.65		52.71
<b>Mean of time</b>		46.44	56.80		55.25
<b>Mean of batch</b>		48.06	53.49		56.95

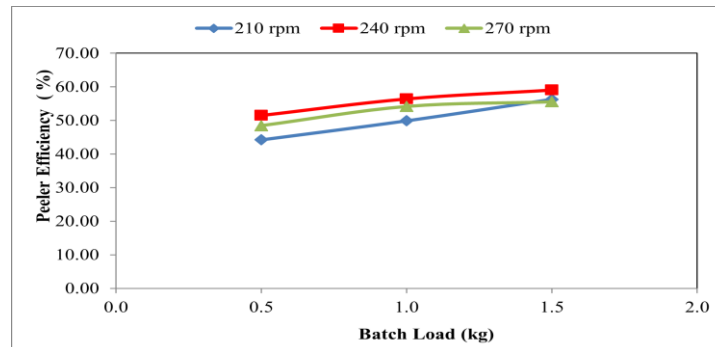
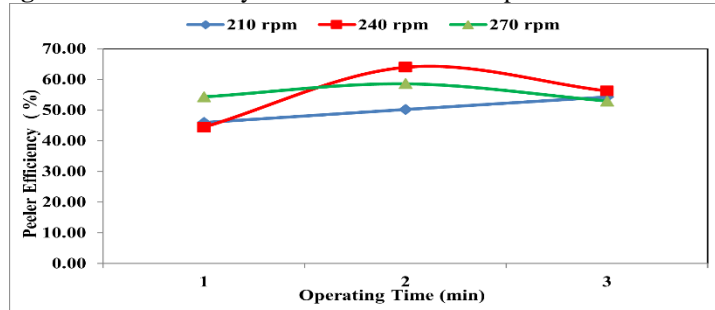
**Fig. 7.** Peeler efficiency at different rotational speeds and batch loads.**Fig. 8.** Machine efficiency at different rotational speeds of disk and operating times.

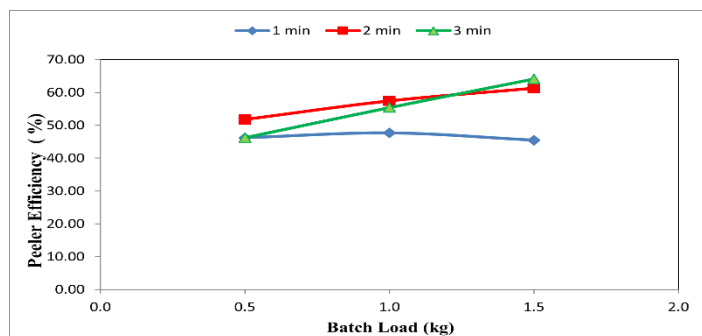

Fig. 9. Machine efficiency at different operating times and batch loads.

Regarding the effect of rotational speed of disk and operating time and on the peeler efficiency, the results indicate that the garlic peeler efficiency increases with increasing the rotational speed of disk and operating time. It increased from 45.93 to 49.00, 50.20 to 56.23 and 54.27 to 52.91 % at 1, 2 and 3 min operating time, respectively, when the rotational speed of disk increased from 210 to 270 rpm. The results also indicate that the garlic peeler efficiency increased from 45.93 to 54.27, 44.40 to 58.58 and 49.00 to 52.91 % at 210, 240 and 270 rpm rotational speed of disk, respectively, when the operating time increased from 1 to 3 min as shown in figure 8.

The results also indicate that the peeler efficiency increased 46.20 to 46.24, 47.67 to 55.40 and 46.47 to 64.11 % at 0.5, 1.0 and 1.5 kg batch loads, respectively, when the operating time increased from 1 to 3 min. The results also indicate that the peeler efficiency increased from 46.20 to 46.47, 51.73 to 61.27 and 46.24 to 64.11 % at 1, 2 and 3 min operating times, respectively, when the batch load increased from 0.5 to 1.5 kg as shown in figure 9.

Multiple regression analysis was carried out to obtain a relationship between the garlic peeler efficiency as dependent variable and different rotational speed of disk, operating time and batch load as independent variables. The best fit for this relationship is presented in the following equation:-

$$\eta_p = 24.66 + 0.04RS + 4.35OT + 8.79PL$$

Where:

$\eta_p$  is the garlic peeler efficiency, %

This equation could be applied in the range of 210 to 270 rpm of rotational speed of disk, from 1 to 3 min operating time and from 0.5 to 1.5 kg batch load.

### 3.3. Damaged cloves percentage:

Table (3) and figures (10, 11 and 12) show the damaged cloves percentage as affected by the rotational speeds of peeler disk from 210 to 270 rpm, the operating times from 1 to 3 min and batch loads from 0.5 to 1.5 kg. The results indicate that the damaged cloves percentage increases with increasing rotational speed of disk and batch load and it decreased with increasing operating time. It indicates that when the rotational speed of disk increased from 210 to 270 rpm, the damaged cloves percentage increased from 0.11 to 0.12 (by 8.33 increment percent) %. It also indicates that when the operating time increased from 1 to 3 min, the damaged cloves percentage decreased from 0.16 to 0.06 (by 62.5 reduction percent) %, while the damaged cloves percentage increased from 0.04 to 0.16 (by 75.0 increment percent) % when the batch load increased from 0.5 to 1.5 kg.

It could be noticed that increasing the rotational speed of disk 210 to 270 rpm, tends to increase the damaged cloves percentage from 0.043 to 0.056, 0.120 to 0.123 and 0.177 to 0.180 % at 0.5, 1.0 and 1.5 kg batch load, respectively, when the rotational speeds of disk increased from 210 to 270 rpm. The results also indicate that the damaged cloves percentage increased from 0.043 to 0.177, 0.030 to 0.130 and 0.56 to 0.180 % at 210, 240 and 270 rpm rotational speeds of disk, respectively, when the batch load increased from 0.5 to 1.5 kg as shown in figure 10.



**Table 3.** Damaged cloves percentage at different rotational speeds of dish, operating times and batch loads.

Speed, rpm	Time, min	Batch Load, kg			Mean
		0.5	1.0	1.5	
Damaged Cloves Percentage, %					
210	1	0.08	0.20	0.26	<b>0.18</b>
	2	0.04	0.10	0.16	<b>0.10</b>
	3	0.01	0.06	0.11	<b>0.06</b>
	<b>Mean</b>	<b>0.043</b>	<b>0.120</b>	<b>0.177</b>	
240	1	0.03	0.08	0.24	<b>0.11</b>
	2	0.04	0.03	0.08	<b>0.05</b>
	3	0.02	0.05	0.07	<b>0.04</b>
	<b>Mean</b>	<b>0.030</b>	<b>0.053</b>	<b>0.130</b>	
270	1	0.10	0.20	0.26	<b>0.19</b>
	2	0.05	0.10	0.16	<b>0.10</b>
	3	0.02	0.07	0.12	<b>0.06</b>
	<b>Mean</b>	<b>0.056</b>	<b>0.123</b>	<b>0.180</b>	
<b>Mean of speed</b>		0.11	0.07		0.12
<b>Mean of time</b>		0.16	0.08		0.06
<b>Mean of batch</b>		0.04	0.10		0.16

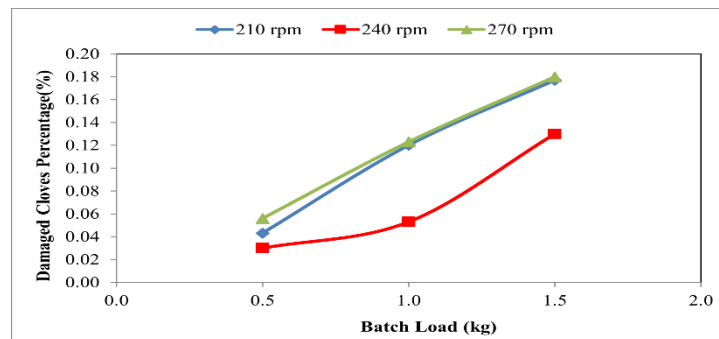
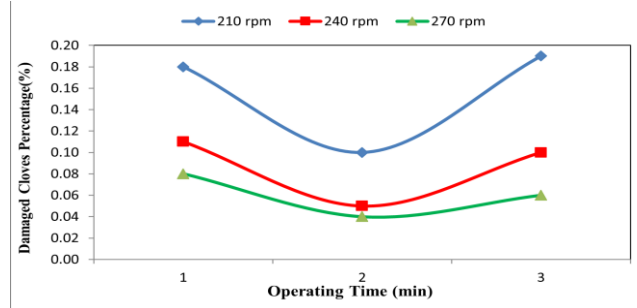
**Fig. 10.** Damage cloves percentage at different rotational speeds and batch loads.**Fig. 11.** Damaged cloves percentage at different rotational speeds of disk and operating times.

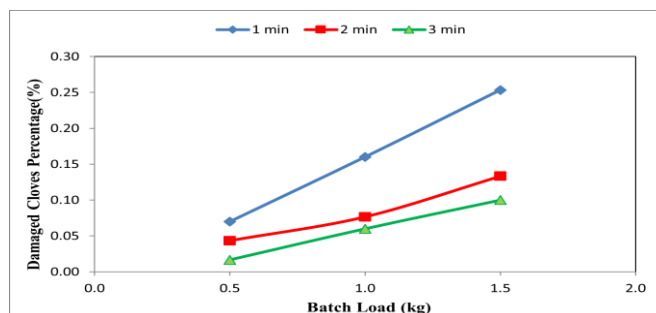

Fig. 12. Damaged cloves percentage at different operating times and batch loads.

Regarding the effect of rotational speed of disk and operating time and on the damaged cloves percentage, the results indicate that the damaged cloves percentage increases with increasing the rotational speed of disk and operating time. It increased from 0.180 to 0.187, 0.100 to 0.103 and 0.060 to 0.070 % at 1, 2 and 3 min operating time, respectively, when the rotational speed of disk increased from 210 to 270 rpm. The results also indicate that the damaged cloves percentage decreased from 0.180 to 0.060, 0.117 to 0.047 and 0.187 to 0.076 % at 210, 240 and 270 rpm rotational speed of disk, respectively, when the operating time increased from 1 to 3 min as shown in figure 11.

The results also indicate that the damaged cloves percentage decreased 0.070 to 0.016, 0.161 to 0.056 and 0.255 to 0.098 % at 0.5, 1.0 and 1.5 kg batch loads, respectively, when the operating time increased from 1 to 3 min. The results also indicate that the peeler efficiency increased from 46.20 to 46.47, 51.73 to 61.27 and 46.24 to 64.11 % at 1, 2 and 3 min operating times, respectively, when the batch load increased from 0.5 to 1.5 kg as shown in figure 12.

Multiple regression analysis was carried out to obtain a relationship between the damaged cloves percentage as dependent variable and different rotational speed of disk, operating time and batch load as independent variables. The best fit for this relationship is presented in the following equation:-

$$DC = 0.044 + 0.0003RS - 0.058OT + 0.107PL \quad R^2 = 0.89$$

Where:

DC is the damaged cloves percentage, %

This equation could be applied in the range of 210 to 270 rpm of rotational speed of disk, from 1 to 3 min operating time and from 0.5 to 1.5 kg batch load.

### 3.4. Specific energy consumption:

Table (4) and figures (13,14 and 15) show the specific energy consumption as affected by the rotational speeds of peeler disk from 210 to 270 rpm, the operating times from 1 to 3 min and batch loads from 0.5 to 1.5 kg. The results indicate that the specific energy consumption decreases with increasing rotational speed of disk and operating time and it increased with increasing batch load. It indicates that when the rotational speed of disk increased from 210 to 270 rpm, the specific energy consumption decreased from 0.093 to 0.082 (by 11.83 reduction percent) kW h kg<sup>-1</sup>. It also indicates that when the operating time increased from 1 to 3 min, the specific energy consumption decreased from 0.160 to 0.040 (by 75.0 reduction percent) kW h kg<sup>-1</sup>, while the specific energy consumption increased from 0.048 to 0.128 (by 62.5 increment percent) kW h kg<sup>-1</sup> when the batch load increased from 0.5 to 1.5 kg.

It could be noticed that increasing the rotational speed of disk 210 to 270 rpm, tends to decrease the specific energy consumption from 0.053 to 0.047, 0.100 to 0.080 and 0.127 to 0.120 kW h kg<sup>-1</sup> at 0.5, 1.0 and 1.5 kg batch load, respectively, when the rotational speeds of disk increased from 210 to 270 rpm. The results also indicate that the specific energy consumption increased from 0.053 to 0.127, 0.043 to 0.137 and 0.047 to 0.120 kW h kg<sup>-1</sup> at 210, 240 and 270 rpm rotational speeds of disk, respectively, when the batch load increased from 0.5 to 1.5 kg as shown in figure 13.

**Table 4.** Specific energy consumption at different rotational speeds of dish, operating times and batch loads.

Speed, rpm	Time, min	Batch Load, kg			Mean
		0.5	1.0	1.5	
Specific Energy Consumption, kW h kg <sup>-1</sup>					
210	1	0.09	0.17	0.23	<b>0.163</b>
	2	0.04	0.08	0.10	<b>0.073</b>
	3	0.03	0.05	0.05	<b>0.043</b>
	<b>Mean</b>	<b>0.053</b>	<b>0.10</b>	<b>0.127</b>	
240	1	0.08	0.16	0.28	<b>0.173</b>
	2	0.03	0.06	0.08	<b>0.057</b>
	3	0.02	0.04	0.05	<b>0.037</b>
	<b>Mean</b>	<b>0.043</b>	<b>0.087</b>	<b>0.137</b>	
270	1	0.07	0.14	0.22	<b>0.143</b>
	2	0.04	0.06	0.09	<b>0.063</b>
	3	0.03	0.04	0.05	<b>0.040</b>
	<b>Mean</b>	<b>0.047</b>	<b>0.080</b>	<b>0.120</b>	
<b>Mean of speed</b>		0.093	0.089		0.082
<b>Mean of time</b>		0.160	0.064		0.040
<b>Mean of batch</b>		0.048	0.089		0.128

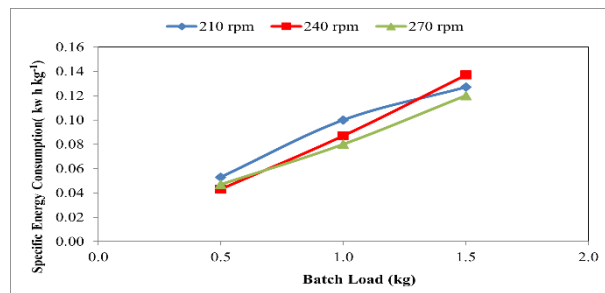
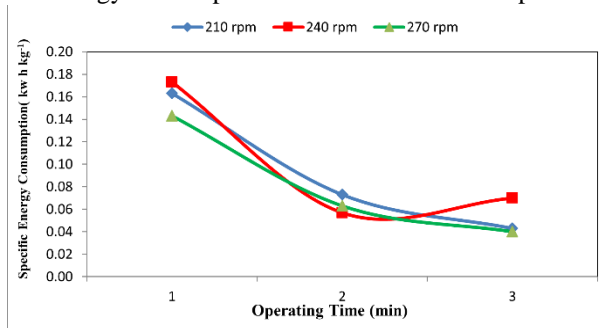
**Fig. 13.** Specific energy consumption at different rotational speeds and batch loads.**Fig. 14.** Specific energy consumption at different rotational speeds of disk and operating times.

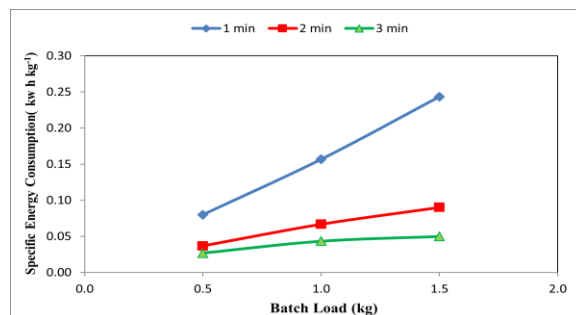

Fig. 15. Specific energy consumption at different operating times and batch loads.

Regarding the effect of rotational speed of disk and operating time and on the specific energy consumption, the results indicate that the specific energy consumption decreases with increasing the rotational speed of disk and operating time. It decreased from 0.163 to 0.143, 0.073 to 0.063 and 0.043 to 0.040 kW h kg<sup>-1</sup> at 1, 2 and 3 min operating time, respectively, when the rotational speed of disk increased from 210 to 270 rpm. The results also indicate that the specific energy consumption decreased from 0.163 to 0.043, 0.173 to 0.037 and 0.143 to 0.040 kW h kg<sup>-1</sup> at 210, 240 and 270 rpm rotational speed of disk, respectively, when the operating time increased from 1 to 3 min as shown in figure 14.

The results also indicate that the specific energy consumption decreased 0.08 to 0.03, 0.16 to 0.04 and 0.24 to 0.05 kW h kg<sup>-1</sup> at 0.5, 1.0 and 1.5 kg batch loads, respectively, when the operating time increased from 1 to 3 min. The results also indicate that the specific energy consumption increased from 0.08 to 0.24, 0.04 to 0.04 and 0.03 to 0.05 kW h kg<sup>-1</sup> at 1, 2 and 3 min operating times, respectively, when the batch load increased from 0.5 to 1.5 kg as shown in figure 15.

Multiple regression analysis was carried out to obtain a relationship between the specific energy consumption as dependent variable and different rotational speed of disk, operating time and batch load as independent variables. The best fit for this relationship is presented in the following equation:-

$$SEC = 0.17 - 0.0002RS - 0.06OT + 0.08PL \quad R^2 = 0.89 \quad (17)$$

Where:

SEC is the specific energy consumption, kW h kg<sup>-1</sup>

This equation could be applied in the range of 210 to 270 rpm of rotational speed of disk, from 1 to 3 min operating time and from 0.5 to 1.5 kg batch load.

### 3.4. Total cost:

Table (5) and figures (16, 17 and 18) show the total cost as affected by the rotational speeds of peeler disk from 210 to 270 rpm, the operating times from 1 to 3 min and batch loads from 0.5 to 1.5 kg. The results indicate that the total cost decreases with increasing rotational speed of disk and operating time and it

increased with increasing batch load. It indicates that when the rotational speed of disk increased from 210 to 270 rpm, the total cost decreased from 0.230 to 0.215 (by 6.52 reduction percent) EGP kg<sup>-1</sup>. It also indicates that when the operating time increased from 1 to 3 min, the total cost decreased from 0.402 to 0.105 (by 73.88 reduction percent) EGP kg<sup>-1</sup>, while the total cost increased from 0.120 to 0.326 (by 63.19 increment percent) EGP kg<sup>-1</sup> when the batch load increased from 0.5 to 1.5 kg.

It could be noticed that increasing the rotational speed of disk 210 to 270 rpm, tends to decrease the total cost from 0.128 to 0.116, 0.231 to 0.218 and 0.330 to 0.310 EGP kg<sup>-1</sup> at 0.5, 1.0 and 1.5 kg batch load, respectively, when the rotational speeds of disk increased from 210 to 270 rpm. The results also indicate that the total cost increased from 0.128 to 0.330, 0.115 to 0.338 and 0.116 to 0.310 EGP kg<sup>-1</sup> at 210, 240 and 270 rpm rotational speeds of disk, respectively, when the batch load increased from 0.5 to 1.5 kg as shown in figure 16.

Regarding the effect of rotational speed of disk and operating time and on the total cost, the results indicate that the total cost decreases with increasing the rotational speed of disk and operating time. It decreased from 0.401 to 0.379, 0.180 to 0.161 and 0.109 to 0.103 EGP kg<sup>-1</sup> at 1, 2 and 3 min operating time, respectively, when the rotational speed of disk increased from 210 to 270 rpm. The results also indicate that the total cost decreased from 0.401 to 0.109, 0.425 to 0.102 and 0.379 to 0.103 EGP kg<sup>-1</sup> at 210, 240 and 270 rpm rotational speed of disk, respectively, when the operating time increased from 1 to 3 min as shown in figure 17.

The results also indicate that the total cost decreased 0.201 to 0.067, 0.389 to 0.112 and 0.615 to 0.135 EGP kg<sup>-1</sup> at 0.5, 1.0 and 1.5 kg batch loads, respectively, when the operating time increased from 1 to 3 min. The results also indicate that the total cost increased from 0.201 to 0.615, 0.091 to 0.229 and 0.067 to 0.135 EGP kg<sup>-1</sup> at 1, 2 and 3 min operating times, respectively, when the batch load increased from 0.5 to 1.5 kg as shown in figure 18.

**Table 5.** Total cost at different rotational speeds of dish, operating times and batch loads.

Speed, rpm	Time, min	Batch Load, kg			Mean
		0.5	1.0	1.5	
		Total Cost, EGP kg <sup>-1</sup>			
210	1	0.21	0.39	0.60	<b>0.401</b>
	2	0.10	0.19	0.25	<b>0.180</b>
	3	0.07	0.12	0.14	<b>0.109</b>
	<b>Mean</b>	<b>0.128</b>	<b>0.231</b>	<b>0.330</b>	
240	1	0.21	0.39	0.67	<b>0.425</b>
	2	0.08	0.15	0.20	<b>0.142</b>
	3	0.06	0.10	0.14	<b>0.102</b>
	<b>Mean</b>	<b>0.115</b>	<b>0.215</b>	<b>0.338</b>	
270	1	0.19	0.39	0.57	<b>0.379</b>
	2	0.09	0.15	0.24	<b>0.161</b>
	3	0.07	0.11	0.13	<b>0.103</b>
	<b>Mean</b>	<b>0.116</b>	<b>0.218</b>	<b>0.310</b>	
<b>Mean of speed</b>		0.230	0.223	0.215	
<b>Mean of time</b>		0.402	0.161	0.105	
<b>Mean of batch</b>		0.120	0.221	0.326	

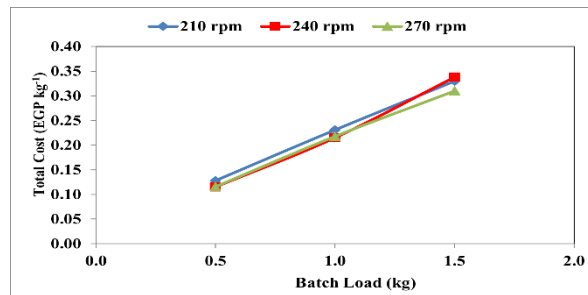
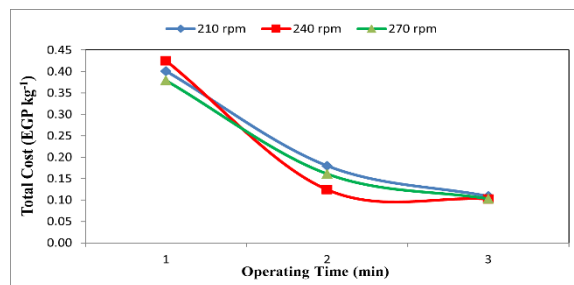
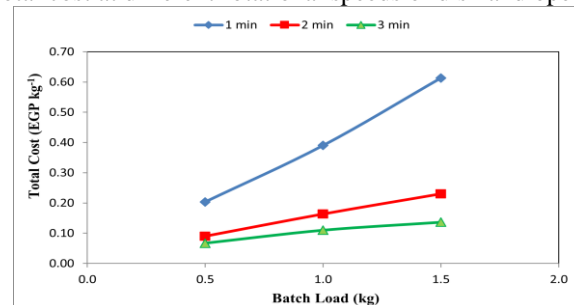
**Fig. 16.** Total cost at different rotational speeds and batch loads.**Fig. 17.** Total cost at different rotational speeds of disk and operating times.**Fig. 18.** Total cost at different operating times and batch loads.

Multiple regression analysis was carried out to obtain a relationship between the total cost as dependent variable and different rotational speed of disk, operating time and batch load as independent variables. The best fit for this relationship is presented in the following equation:-

$$TC = 0.37 - 0.0002RS - 0.15OT + 0.21PI \text{ operating time, respectively.} \quad (18)$$

Where:

TC is the total cost, EGP kg<sup>-1</sup>

This equation could be applied in the range of 210 to 270 rpm of rotational speed of disk, from 1 to 3 min operating time and from 0.5 to 1.5 kg batch load.

### Conclusions

The experiment was carried out to study is to develop, manufacturing and evaluating local garlic peeler which is made from local raw materials, low cost in operating, easy and sample to handle. To achieve that study the effect of different rotational speeds of disk (210, 240 and 270 rpm), operating times (1, 2 and 3 min) and batch loads (0.5, 1.0 and 1.5 kg) on the peeler productivity, efficiency, damaged cloves percentage, specific energy consumption and costs. The obtained results indicated that the garlic peeler productivity increased from 17.88 to 19.33 and 8.52 to 29.04 kg h<sup>-1</sup>, with increasing rotational speed of disk and operating time, respectively and it decreased from 28.84 to 12.46 kg h<sup>-1</sup> with increasing batch load from 0.5 to 1.5 kg. The peeler efficiency increased with increasing rotational speed of disk, operating time and batch load. The highest value of damaged cloves percentage (0.26%) was found

for 270 rpm rotational speed of disk at 1 min of operating time for 1.5 batch load. The specific energy consumption decreases with increasing rotational speed of disk and operating time. The total cost of garlic peeler decreased from 0.230 to 0.215 and 0.402 to 0.105 EGP kg<sup>-1</sup> with increasing rotational speed of disk and operating time, respectively.

### References

- Anonymous (2001).** Garlic cultivation in India. Technical Bulletin No. 7, National Horticultural Research and Development Foundation (NHRDF), Nasik, India
- Badr, M. M. (2017).** Development and evaluation of a Garlic "Allium sativum" peeling prototype. *Misr J. Ag. Eng.*, 34 (2): 1023 – 1042.
- Dhananjay, G.D., Choudhary, S. K. and Ninawe, A.P. 2015.** Methodology for design and fabrication of garlic peeling machine. *International Journal of Scientific Research and Development* 2(11), 2321-0613.
- FAO (2019).** Production and trade statistics. FAO, Rome, Italy.
- Kurt, G. (1979).** Engineering formulas. 3<sup>rd</sup>. Ed. Mc Graw – Hill book Co.
- Lanzotti, V., F. Scala and G. Bonanomi (2014).** Compounds from Allium species with cytotoxic and antimicrobial activity. *Phytochemistry Reviews*, 13: 769 - 791.
- Mudgal, V. D. and P. S. Champawat (2008).** Influence of operating parameters on performance of air-assisted garlic peeler. *Journal of Agricultural Engineering (New Delhi)*. 45 :3,45-48

### تطوير وتقييم آلة لتفشير الثوم

حسين عبده قاسم \* ، عادل حامد بهنساوي\*\* ، طه مختار عاشور\*\* ، السيد جمعه خاطر\*\*\* ، رجب قاسم محمود\*\*\*\*

يهدف هذا البحث الى تطوير وتصنيع وتقييم آلة لتفشير فصوص الثوم التي تم تصنيعها من مواد محلية حيث تم دراسة تأثير السرعات المختلفة لقرص الدوار (210، 240، 270 لفة دقيقة<sup>-1</sup>) وزمن التشغيل (1، 2، 3 دقائق) وسعة التحميل (0.5، 1.0، 1.5 كجم). وقد تم تقدير انتاجية الآلة وكفاءة ونسبة الضرر ومعدل استهلاك الطاقة النوعية والتكاليف الكلية. وقد اظهرت النتائج ان انتاجية الآلة زادت من 17.88 إلى 19.33 و من 8.52 إلى 29.04 كجم ساعة<sup>-1</sup> بزيادة السرعة الدورانية للقرص وزمن التشغيل علي الترتيب. وانخفضت من 28.84 إلى 12.49 كجم ساعة<sup>-1</sup> بزيادة سعة التحميل من 0.5 إلى 1.5 كجم. كما زادت كفاءة الآلة بزيادة سرعة دوران القرص وزمن التشغيل وسعة التحميل. وكانت أعلى قيمة لنسبة الضرر في فصوص الثوم 0.26% مع سرعة دوران القرص 270 لفة/دقيقة عند زمن التشغيل 1 دقيقة وسعة التحميل 1.5 كجم. وانخفض معدل استهلاك الطاقة النوعية بزيادة سرعة دوران القرص وزمن التشغيل. انخفضت التكاليف الكلية 0.230 إلى 0.215 ومن 0.402 إلى 0.105 جنيه كجم<sup>-1</sup> بزيادة سرعة دوران القرص وزمن التشغيل التوالي .

\*طالب دراسات عليا – كلية الزراعة بمشتر – جامعة بنها

\*\*استاذ الهندسة الزراعية - كلية الزراعة بمشتر – جامعة بنها

\*\*\*استاذ الهندسة الزراعية المساعد- كلية الزراعة بمشتر – جامعة بنها

\*\*\*\*مدرس الهندسة الزراعية - كلية الهندسة الزراعية (فصول أسيوط) – جامعة الأزهر